

MACHINES A CAFE ET DISTRIBUTEURS AUTOMATIQUES

*Soyez prêt avec notre gamme de
pièces détachées, consommables
et accessoires*

REPARTONS
ENSEMBLE

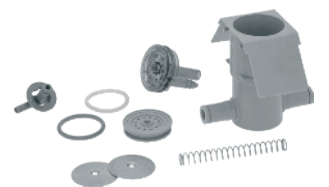

PRODUITS D'HYGIENE HAUTE QUALITE POUR LE LIEU DE TRAVAIL	4
MACHINES A CAFE	6
NETTOYANTS	7
PIECES DETACHEES	8
TRAITEMENT DE L'EAU	31
CONSOMMABLES	32
OUTILS	39
DISTRIBUTEURS AUTOMATIQUES	42
KITS DE MAINTENANCE	43
CONSOMMABLES	45



PRODUITS D'HYGIENE HAUTE QUALITE POUR LE LIEU DE TRAVAIL



LF Code: 3091061
GEV Code: 802500



KIT PROTECTION PERSONNEL

le kit est composé de:
3091048 masque lavable double couche (5 pcs)
3716010 visière faciale
3092360 détergent mains IDRAL70 (1 L)



LF Code: 3092363
GEV Code: LF3092363



LF Code: 3092361
GEV Code: 850137



LF Code: 3092354
GEV Code: LF3092354

ASSAINISSANT SURFACESI LUXEDO 1000 ml

élimine les germes et les bactéries
idéal pour assainir les lieux de travail
une action efficace de purification et
d'assainissement
non agressif sur les surfaces
n'a pas besoin d'être clarifiée
ne laisse aucun résidu chimique agressif
efficacité garantie
adapté au plan HACCP



LF Code: 7131860
GEV Code: LF7131860

GEL HYDROALCOOLIQUE CLEANSI 80%

teneur élevée en alcool 80%
désinfecte toutes les surfaces
évaporation rapide
sans laisser de résidus et taches
désinfectant enregistré en Allemagne (No.
90037)
élimine germes, allergènes, salissures,
empreintes de pas, taches de graisse
prêt à l'emploi, pas besoin de rinçage
convient au plan d'hygiène HACCP



LF Code: 3716010
GEV Code: 802512

DESINFECTANT SANIBACT CONCENTRE 1 L

produit HACCP
désinfectant bactéricide et levuricide concentré
dilution max jusqu'à 25 L
les bactéries conforme aux tests
EN1276-EN13697
les moisissures conforme au test EN13697
efficace contre virus de grippe, VIH et hépatite B/C
ne laisse aucune odeur ou résidu
à utiliser sur évaporateurs et toutes les surfaces



LF Code: 3092226
GEV Code: LF3092226

GEL HYDROALCOOLIQUE

BACTIMAINS GHA 300 ml
traitement hygiénique et désinfection
chirurgicale des mains par friction
contient de alcool ethylique
N°CAS 64-17-5 - 70,2% (m/m)
produit réservé à un usage exclusivement
professionnel

VISIERE EN ABS UNISEXE 260x210 mm

NE CONVIENT POUR UN USAGE MEDICAL
CE N'EST PAS UN DISPOSITIF DE PROTECTION
INDIVIDUELLE (DPI) - épaisseur 0,25 mm
matériaux testés et approuvés
désinfection simple avec un désinfectant
pour éviter les traces dans la zone visible,
il est recommandé de nettoyer avec de l'eau
après la désinfection - PAS DE CERTIFICAT CE

NETTOYANT DESINFECTANT ENZYMATIQUE 5 L

DEGRES L+ 100% biodégradable
recommandé pour les sols, murs, plan de
travail, dallages, epoxy, évaporateurs ...
élimine tous les résidus organiques, même
incrustés
assure une hygiène parfaite des surfaces
non agressif pour l'utilisateur
empêche le blocage des canalisations grâce à
l'action continue des enzymes
dosage : 1% dans l'eau chaude

PRODUITS D'HYGIENE HAUTE QUALITE POUR LE LIEU DE TRAVAIL

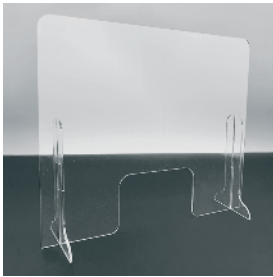

LF Code: 3091060
GEV Code: LF3091060

PLEXIGLASS 800x700x5 mm

séparateur en plexiglas
avec un trou passe-papiers 300x200 mm
pieds d'appui à encastrer 200 mm



LF Code: 3716011
GEV Code: LF3716011

SUPPORT FLACON DETERGENT AVEC ETAGERE

entièrement conçu en acier inox AISI 304
structure robuste autoportante h. 100 cm
support flacon max. ø 100 mm
(flacon distributeur non compris)
2 colliers pour éventuelle fixation du flacon
étagère pour gants, lingettes ou masques
tous les éléments sont amovibles
pour faciliter le nettoyage et la désinfection



LF Code: 3716012
GEV Code: LF3716012

COLONNE INOX SUPPORT DETERGENT

entièrement conçu en acier inox AISI 304
structure robuste autoportante h. 109 cm
support flacon max. ø 100 mm
(distributeur non compris)
préconisé avec distributeur code LF 3092366
1 collier pour éventuelle fixation du flacon
étagère pour gants, lingettes
tous les éléments sont amovibles
pour faciliter le nettoyage et la désinfection



LF Code: 3092366
GEV Code: LF3092366

DISTRIBUTEUR DE DETERGENT ABS 1000 mm

convient aux liquides et gels
fonctionnement : 8 piles AA non incluses
(20000 utilisations CA)
alimentation AC 220V incluse
capacité: 1000 ml
capteur infrarouge automatique
kit de fixation murale inclus
dimensions: 262x123x114 mm
poids: 0,85 kg



LF Code: 3010134
GEV Code: LF3010134

PURIFICATEUR D'AIR IONISEUR 700

tension DC 6V /4 piles D (non incluses)
production d'ozone 12 mg/h
pour réfrigérateurs jusqu'à 700 L
dimensions 133x73x140 mm
pour tuer les bactéries et les virus et
empêcher le développement des moisissures
pour éliminer les pesticides et les herbicides
et odeurs rassis
pour réduire la détérioration des aliments



LF Code: 3610036
GEV Code: LF3610036

INDOORS AIR OZONIZER PLH-M200CB

AC 100-240V 50/60HZ adapter DC 12V 10W
ozone production 200 mg/h
for areas measuring 50-80 m³
dimensions 162x162x230 mm
eliminates viruses and bacteria in the air
eliminates all odours



LF Code: 3010059
GEV Code: LF3610059

OZONEUR AIR /EAU CH-KTB

hygiénisation naturelle
90W 3A 220V 50/60Hz
production d'ozone 2800 mg/h
nettoyage jusqu'à 200 m³
élimine bactéries et virus dans l'air et l'eau
enlève tous les odeurs
réduit la détérioration des aliments



LF Code: 3610050
GEV Code: LF3610050

OZONATEUR AIR/EAU NT-T-N 10 G

hygiénisation naturelle
260W 3A 220V 50/60Hz
production ozone 10 g/h
dimensions 400x300x770 mm
élimine bactéries et virus dans l'air et l'eau
élimine toutes les odeurs
aide à réduire la dégradation des aliments

VEUILLEZ NOTER QUE LES IMAGES DE PRODUITS
AFFICHEES PEUVENT NE PAS CORRESPONDRE A
CELLES QUI SONT PROPOSEES SUR NOTRE SITE
INTERNET.



MACHINES A CAFE

NETTOYANTS

PIECES DETACHEES

TRAITEMENT DE L'EAU

CONSOMMABLES

OUTILS

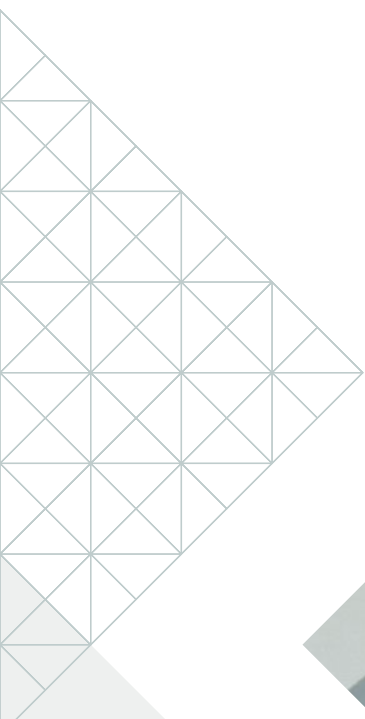

MACHINES A CAFE NETTOYANTS



LF Code: 3092355

NETTOYANT CAPPUCCINO PERFECT 1 L

pour le nettoyage des mousses à lait
pour modalité d'utilisation, voir notice jointe
code GTIN/EAN 4064145110006



LF Code: 3092143

DETERGENT COFFEE CLEAN 900 g

détergent pour MACHINES A CAFE
idéal pour le nettoyage filtres et
porte-filtres, taches de gras et café sur
tasses et soucoupes
pour modalité d'utilisation, voir notice jointe
code GTIN/EAN 4064145109994



LF Code: 1092213

DETERGENT GRIND CLEAN 340 g

détergent pour le nettoyage des meules
produit à base de grain naturel
100% biologique
pour modalité d'utilisation, voir notice jointe



LF Code: 1092017

DETERGENT PULY GRIND HOPPER 200 ml

nettoie et désinfecte
sans rinçage interne et externe de la trémie
moulin-café
non inflammable, sans danger
substances actives naturelles,
doux sur les mains
ne laisse pas de résidus et ni odeurs
conforme aux normes HACCP



LF Code: 3092352

DETARTRANT SCALE CLEAN 1 kg

détartrant acide pour surfaces en aluminium
cuivre, lait, fer
pour taches de gras et café sur tasses et
soucoupes



LF Code: 3092290

DETERGENT DESINFECTANT "SANITRE" 1 L

désinfectant amphotère pour surfaces
alimentaires
pour le nettoyage et la désinfection des
sols, plans de travail et l'équipement ali-
mentaire
Reg. N° 19277 du ministère de la Santé.
pour modalité d'utilisation, voir notice jointe



LF Code: 3092326

DETERGENT PULYBAR IGIENIC 1000 ml

nettoie et désinfecte:
surfaces aciers inox, plastiques, verres,
laqués, vernis, miroirs, cristaux
idéal pour le nettoyage de:
hottes, tables, fers, trancheurs, machines
à café, moulins à café, couteaux, plans de
travail
ne mousse pas, ne laisse aucun résidus ni
odeurs
pas besoin de rinçage
conforme aux normes HACCP
pour modalité d'utilisation, voir notice jointe

VOIR LA LISTE COMPLETE
SUR NOTRE SITE INTERNET
WWW.EPGC.COM

MACHINES A CAFE

PIECES DETACHEES

SOUPAPES DE SECURITE



1



2

Photo	Code LF	Notes techniques	Adaptable sur
1	1515100	ø 3/8" M 1.8 bar CE-PED	TOUTES MARQUES
1	1515120	ø 3/8" M 1.9 bar CE-PED	TOUTES MARQUES
1	5072121	ø 3/8" M 2.5 bar CE-PED - CW510L	TOUTES MARQUES
2	1515110	ø 1/2" M 1.8 bar CE-PED	TOUTES MARQUES
2	1523022	ø 1/2" M 1.5 bar CE-PED	SPAZIALE

VALVES



1



2



3

Photo	Code LF	Notes techniques	Adaptable sur
1	1523537	ø 1/4" M VITON	ALL BRANDS - TUTTE LE MARCHE
2	1523534	ø 1/4" M PTFE ET VITON	ALL BRANDS - TUTTE LE MARCHE
3	1523538	ø 1/4" M	ALL BRANDS - TUTTE LE MARCHE

VALVES SPECIFIQUES



1



2



3



4



5

Photo	Code LF	Notes techniques	Adaptable sur
1	1523651	ø 3/8" M LAITON	PROMAC - RANCILIO
2	1515016	ø 1/4" M LAITON	EXPOBAR
3	1523004	ø 1/4" M	BRASILIA
4	1523051	ø 3/8" M	PROMAC - RANCILIO
5	1523073	ø 1/4" M	CASADIO - CIMBALI - FAEMA

MACHINES A CAFE PIECES DETACHEES

FILTRES A CAFE ASTORIA/CMA



Photo	Code LF	Modèle	Adaptable sur	Notes	ø bord - hauteur (H)
1	1160050	1 CUP - 6 gr	ASTORIA/CMA 27146	---	70 - 19.5 mm
1	1160052	1 CUP - 7 gr	ASTORIA/CMA 27142	---	70 - 24.5 mm
2	1160529	2 CUPS - 12 gr	ASTORIA/CMA 27121 - 27176	---	70 - 22 mm
2	1160053	2 CUPS - 14 gr	ASTORIA/CMA 27171	---	70 - 24.5 mm
3	1160345	2 CUPS - 18 gr	ASTORIA/CMA 27190	---	70 - 28 mm
4	1160339	BLIND - CIECO	ASTORIA/CMA 27173	---	70 - 17 mm
1	1160276	1 CUP - 7 gr	ASTORIA/CMA 27144000	PLUS4YOU	65 - 25 mm
2	1160277	2 CUPS - 14 gr	ASTORIA/CMA 27175000	PLUS4YOU	65 - 27.5 mm
4	1160278	BLIND - CIECO	ASTORIA/CMA 27175001	PLUS4YOU	65 - 25 mm
5	1160503	POD 1 CUP	ASTORIA/CMA	---	70 - 17 mm
5	1160504	POD 2 CUPS	ASTORIA/CMA	---	70 - 21.5 mm

FILTRES A CAFE CASADIO



Photo	Code LF	Modèle	Adaptable sur	Notes	ø bord - hauteur (H)
1	1160251	1 TASSE - 6 gr	CASADIO 457367000	---	70 - 20.5 mm
1	1160335	1 TASSE - 7 gr	CASADIO 457368000	---	70 - 24.5 mm
2	1160252	2 TASSES - 12 gr	CASADIO	---	70 - 21 mm
2	1160337	2 TASSES - 14 gr	CASADIO 457369000	---	70 - 24.5 mm
1	1160281	1 TASSE - 7 gr	CASADIO	AISI 430 ECONOMIC	70 - 24.5 mm
2	1160282	2 TASSES - 14 gr	CASADIO	AISI 430 ECONOMIC	70 - 25 mm
3	1160293	MEMBRANE EN EPDM	CASADIO 457058000	---	50 mm

VOIR LA LISTE COMPLETE
SUR NOTRE SITE INTERNET
WWW.EPGC.COM

MACHINES A CAFE

PIECES DETACHEES

FILTRES A CAFE CIMBALI



Photo	Code LF	Modèle	Adaptable sur	Notes	ø bord - hauteur (H)
1	1160257	1 TASSE - 6 gr	CIMBALI 457-249-000 / 457-249-010	---	68 - 22.5 mm
1	1160085	1 TASSE - 6 gr	CIMBALI 457-232-000	---	68 - 18 mm
1	1160266	1 TASSE - 7 gr	CIMBALI 457-163-000	---	68 - 24 mm
1	1160335	1 TASSE - 7 gr	CIMBALI 457-368-000	M27 2008	70 - 24.5 mm
2	1160086	2 TASSES - 12 gr	CIMBALI 457-234-000	---	68 - 19 mm
2	1160267	2 TASSES - 12 gr	CIMBALI 457-233-000	---	68 - 22 mm
2	1160258	2 TASSES - 14 gr	CIMBALI 457-164-000 / 458-171-000	---	68 - 25 mm
2	1160337	2 TASSES - 14 gr	CIMBALI 457-369-000	M27 2008	70 - 24.5 mm
3	5104605	3 TASSES - 21 gr	CIMBALI	---	68 - 28 mm
4	1160293	MEMBRANE EN EPDM	CIMBALI 457-058-000	---	50 mm
5	1160506	1 TASSE	CIMBALI 457-313-000	---	68 - 18.5 mm

FILTRES A CAFE GAGGIA



Photo	Code LF	Modèle	Adaptable sur	Notes	ø bord - hauteur (H)
1	1160261	1 TASSE - 7 gr	GAGGIA WGANF08/004/B / NF08/004	---	68 - 24.5 mm
2	1160262	2 TASSES - 14 gr	GAGGIA WGANF08/005/B / NF08/005	---	68 - 24.5 mm
2	5104605	3 TASSES - 21 gr	GAGGIA	---	68 - 28 mm
3	1160339	AVEUGLE	GAGGIA WGANF08/006	---	70 - 17 mm
4	1160199	1 TASSE	GAGGIA 124653221	---	60 - 20 mm
5	1160200	2 TASSES	GAGGIA 124650221	---	60 - 25.5 mm
6	1160503	1 TASSE	GAGGIA	---	70 - 17 mm
6	1160504	2 TASSES	GAGGIA	---	70 - 21.5 mm

MACHINES A CAFE PIECES DETACHEES

FILTRES A CAFE MARZOCCO



Photo	Code LF	Modèle	Adaptable sur	Notes	ø bord - hauteur (H)
1	1160025	1 TASSE - 7 gr	MARZOCCO L115/A	---	70 - 27 mm
2	1160336	2 TASSES - 14 gr	MARZOCCO L116/A	---	70 - 26.5 mm
2	1160345	2 TASSES - 18 gr	MARZOCCO 5.133	---	70 - 28 mm
3	1160019	2 TASSES - 12 gr - H19	MARZOCCO 5.128	---	70 - 19 mm
3	1160018	2 TASSES - H22	MARZOCCO 5.127	---	70 - 22 mm
4	1160339	AVEUGLE	MARZOCCO L115/C	---	70 - 17 mm

FILTRES A CAFE NUOVA SIMONELLI



Photo	Code LF	Modèle	Adaptable sur	Notes	ø bord - hauteur (H)
1	1160070	1 TASSE - 6 gr	NUOVA SIMONELLI 03000321	---	70 - 21.5 mm
1	1160072	1 TASSE - 7 gr	NUOVA SIMONELLI 03000072 / 17000047	---	70 - 24 mm
2	1160071	2 TASSES - 12 gr	NUOVA SIMONELLI 03000322	---	70 - 21.5 mm
2	1160053	2 TASSES - 14 gr	NUOVA SIMONELLI 03000073 / 17000048	---	70 - 24.5 mm
2	1160345	2 TASSES - 18 gr	NUOVA SIMONELLI	---	70 - 28 mm
3	1160339	AVEUGLE	NUOVA SIMONELLI 03000107	---	70 - 17 mm

VOIR LA LISTE COMPLETE
SUR NOTRE SITE INTERNET
WWW.EPGC.COM

MACHINES A CAFE

PIECES DETACHEES

PORTE-FILTRES ASTORIA/CMA



Photo	Code LF	Ailettes	Poignée	Bec	Filtre	Ressort	Adaptable sur	Pour modèle machine
1	1165076	7 mm	M12	3/8	NON	NON	ASTORIA/CMA 27311056	CALYPSO - PLUS4YOU
2	1165116	7 mm	M12	3/8	NON	NON	ASTORIA/CMA 27311056	CALYPSO - PLUS4YOU
3	1165079	7 mm	M12	3/8	NON	NON	ASTORIA/CMA 27311057	CALYPSO - PLUS4YOU
4	1165115	7 mm	M12	3/8	NON	NON	ASTORIA/CMA 27311057	CALYPSO - PLUS4YOU
5	1165114	7 mm	M12	3/8	NON	NON	ASTORIA/CMA	CALYPSO - PLUS4YOU

PORTE-FILTRES CASADIO



Photo	Code LF	Ailettes	Poignée	Bec	Filtre	Ressort	Adaptable sur	Pour modèle machine
1	1165096	6.3 mm	M10	M16	NON	OUI	CASADIO 958577020	DIECIA - DIECIS - DODICIA - DODICIS - VENTI
2	1165097	6.3 mm	M10	M16	NON	OUI	CASADIO 958578020	DIECIA - DIECIS - DODICIA - DODICIS - VENTI
3	5076313	6.3 mm	M10	M16	NON	NON	CASADIO	DIECIA - DIECIS - DODICIA - DODICIS - VENTI
4	5074187	6.3 mm	M10	M16	NON	NON	CASADIO	DIECIA - DIECIS - DODICIA - DODICIS - VENTI
5	1165142	6.3 mm	M10	M16	NON	NON	CASADIO 457355017	DIECIA - DIECIS - DODICIA - DODICIS - VENTI

MACHINES A CAFE PIECES DETACHEES

PORTE-FILTRES CIMBALI



Photo	Code LF	Ailettes	Poignée	Bec	Filtre	Ressort	Adaptable sur	Pour modèle machine
1	5076313	6.4 mm	M10	M16	NON	NON	CIMBALI 958-577-070F	M27 2008
2	5074187	6.4 mm	M10	M16	NON	NON	CIMBALI 958-578-070F	M27 2008
3	1165206	6.2 mm	M10	M16	NON	OUI	CIMBALI 947-882-030	M100
4	1165207	6.2 mm	M10	M16	NON	OUI	CIMBALI 947-881-030	M100
5	1165204	6.2 mm	M10	M16	NON	OUI	CIMBALI 947-751-040	M100
6	1165205	6.2 mm	M10	M16	NON	OUI	CIMBALI 947-752-040	M100

PORTE-FILTRES FAEMA



Photo	Code LF	Ailettes	Poignée	Bec	Filtre	Ressort	Adaptable sur	Pour modèle machine
1 - ORIGINAL	1165025	6.3 mm	SCREW - A VITE	3/8	OUI	OUI	FAEMA 993711010	E61 - E61 JUBILE'
2 - ORIGINAL	1165024	6.3 mm	SCREW - A VITE	3/8	OUI	OUI	FAEMA 993710010	E61 - E61 JUBILE'
3	1165014	7 mm	SCREW - A VITE	3/8	NON	NON	FAEMA	E61 - E61 JUBILE'
4	5014055	7 mm	M10	3/8	6 gr	OUI	FAEMA 457889020	E91-E92-E97-E98-DUE-SMART
5	5014054	7 mm	M10	3/8	12 gr	OUI	FAEMA 457888020	E91-E92-E97-E98-DUE-SMART
6	1165015	7 mm	M10	3/8	NON	NON	FAEMA	E91-E92-E97-E98-DUE-SMART
6	1165022	7 mm	M12	3/8	NON	NON	FAEMA	E91-E92-E97-E98-DUE-SMART

VOIR LA LISTE COMPLETE
SUR NOTRE SITE INTERNET
WWW.EPGC.COM

MACHINES A CAFE

PIECES DETACHEES

PORTE-FILTRES GAGGIA



Photo	Code LF	Ailettes	Poignée	Bec	Filtre	Ressort	Adaptable sur	Pour modèle machine
1	1165109	7 mm	M10	3/8	NON	NON	GAGGIA 8027085000	DECO - D90 - E90 - GD - GE - LCD - XD - XE
2	1165108	7 mm	M10	3/8	NON	NON	GAGGIA 8027086000	DECO - D90 - E90 - GD - GE - LCD - XD - XE
3	1165026	7 mm	M10	3/8	NON	NON	GAGGIA WGA26G0104	DECO - D90 - E90 - GD - GE - LCD - XD - XE
4	1165018	4.0 mm	M12	3/8	NON	OUI	GAGGIA S395307	G105 - G106

PORTE-FILTRES MARZOCCO



Photo	Code LF	Ailettes	Poignée	Bec	Filtre	Ressort	Adaptable sur	Pour modèle machine
1	1165234	6.0 mm	M12	---	NON	NON	MARZOCCO L111/1AC	TOUS MODELES
2	5055348	6.0 mm	M12	---	NON	NON	MARZOCCO L111/2NAC	TOUS MODELES
3	5038168	6.0 mm	M12	3/8	NON	OUI	MARZOCCO L111/1	TOUS MODELES
4	5085061	6.0 mm	M12	3/8	NON	OUI	MARZOCCO L111/2N	TOUS MODELES

PORTE-FILTRES NUOVA SIMONELLI



Photo	Code LF	Ailettes	Poignée	Bec	Filtre	Ressort	Adaptable sur	Pour modèle machine
1	1165045	7 mm	M10	3/8	6 gr	OUI	NUOVA SIMONELLI 98005024	APPIA - AURELIA - AURELIAII - PREMIER - PROGRAM
2	1165055	7 mm	M10	3/8	12 gr	OUI	NUOVA SIMONELLI 98005024	APPIA - AURELIA - AURELIAII - PREMIER - PROGRAM
3	1165012	7 mm	M10	3/8	NO	NON	NUOVA SIMONELLI 06200092	APPIA - AURELIA - AURELIAII - PREMIER - PROGRAM

MACHINES A CAFE PIECES DETACHEES

PORTE-FILTRES RANCILIO



Photo	Code LF	Ailettes	Poignée	Bec	Filtre	Ressort	Adaptable sur	Pour modèle machine
1	5076427	6 mm	A VISSER	3/8	NON	OUI	RANCILIO 10071021	CLASSE10/9/8/7/6 - EPOCA
2	5077808	6 mm	A VISSER	3/8	NON	OUI	RANCILIO 10071022	CLASSE10/9/8/7/6 - EPOCA
3	1165214	6 mm	A VISSER - INCLINE	3/8	NON	OUI	RANCILIO 10071118	CLASSE11/10/9/8/7/6 - EPOCA - EPOCA NEW
4	1165215	6 mm	A VISSER - INCLINE	3/8	NON	OUI	RANCILIO 10071137	CLASSE11/10/9/8/7/6 - EPOCA - EPOCA NEW
5	1165040	6.5 mm	M12	3/8	7 gr	OUI	RANCILIO	TOUS MODELES
6	1165042	6.5 mm	M12	3/8	14 gr	OUI	RANCILIO	TOUS MODELES

PORTE-FILTRES SAN MARCO



Photo	Code LF	Ailettes	Poignée	Bec	Filtre	Ressort	Adaptable sur	Pour modèle machine
1	1165080	7.4 mm	M10	3/8	NON	NON	SAN MARCO 400154	105 - 100 - 95 - 85 - LEVA
2	1165021	7.4 mm	M10	3/8	NON	NON	SAN MARCO 400154	105 - 100 - 95 - 85 - LEVA
3	1165051	7.4 mm	M10	3/8	NON	NON	SAN MARCO 502034	105 - 100 - 95 - 85 - LEVA
4	1160024	7.4 mm	M10	3/8	NON	NON	SAN MARCO 502750	100 - 105 - 105 NEW

VOIR LA LISTE COMPLETE
SUR NOTRE SITE INTERNET
WWW.EPGC.COM

MACHINES A CAFE

PIECES DETACHEES

PORTE-FILTRES SPAZIALE



Photo	Code LF	Ailettes	Poignée	Bec	Filtre	Ressort	Adaptable sur	Pour modèle machine
1	1165090	6 mm	M12x1.5	3/8	7 gr	OUI	SPAZIALE 02891	TOUS MODELES
2	1165091	6 mm	M12x1.5	3/8	14 gr	OUI	SPAZIALE 02891	TOUS MODELES
3	1165057	6 mm	M12x1.5	3/8	NON	NON	SPAZIALE 02891	TOUS MODELES
4	1165056	6 mm	M12	3/8	NON	NON	SPAZIALE	TOUS MODELES



Code LF: 1022502



Code LF: 1022501

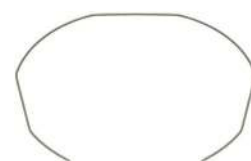

Code LF: 1250101

BEC PORTE-FILTRE 2 TASSES ø 3/8"



Code LF: 1486050

BEC PORTE-FILTRE 1 TASSE ø 3/8"



Code LF: 1486049

RESSORT FERMETURE FILTRE ø 1,00 mm INOX



Code LF: 1486054

JOINT PORTE-FILTRE ø 73x57x8 mm

avec encoches internes
en silicone résistant à la chaleur,
matière souple pour une facilité
d'installation sur le groupe
meilleur longévité et excellente étanchéité
adaptable pour groupe type E61

JOINT PORTE-FILTRE ø 71x56x9 mm

conique
en silicone résistant à la chaleur,
matière souple pour une facilité
d'installation sur le groupe
meilleur longévité et excellente étanchéité
adaptable pour machine NUOVA SIMONELLI
AURELIA
adaptable pour machine VICTORIA ARDUINO
adaptable pour machine CIMBALI

JOINT PORTE-FILTRE ø 74x57,5x8,5 mm

avec encoches externes
en silicone résistant à la chaleur,
matière souple pour une facilité
d'installation sur le groupe
meilleur longévité et excellente étanchéité
adaptable pour machines RANCILIO

MACHINES A CAFE PIECES DETACHEES

JOINTS DE PORTE-FILTRES ASTORIA/CMA



Photo	Code LF	Dimensions (mm)	Notes	Adaptable sur	Pour modèle machine
1	1486030	ø 72x56x8	ENCOCHES INTERNES	ASTORIA/CMA 12217	STANDARD
1	1486029	ø 72x56x8.5	ENCOCHES INTERNES	ASTORIA/CMA 12215	STANDARD
1	1786062	ø 72x56x8	ORIGINAL / ENCOCHES INTERNES	ASTORIA/CMA 12217	STANDARD
1	1186678	ø 72x56x8.5	ORIGINAL / ENCOCHES INTERNES	ASTORIA/CMA 12215	STANDARD
2	1186622	ø 72x56x8	---	ASTORIA/CMA	STANDARD
3	1186650	ø 67x56x5.5	ORIGINAL	ASTORIA/CMA 12216	RAPALLO AL
3	1186656	ø 67x56x6	---	ASTORIA/CMA 12219	RAPALLO AL
4	1786056	ø 64x52x6.3	ENCOCHES INTERNES	ASTORIA/CMA 12217001	PLUS4YOU
4	5047859	ø 64x52x7	ENCOCHES INTERNES	ASTORIA/CMA 12217002	PLUS4YOU
4	5035642	ø 64x52x6.3	ORIGINAL / ENCOCHES INTERNES	ASTORIA/CMA 12217001	PLUS4YOU
4	1486043	ø 64x52x7	ORIGINAL / ENCOCHES INTERNES	ASTORIA/CMA 12217002	PLUS4YOU
5	1486009	ø 53x42x8	ORIGINAL	ASTORIA/CMA 12653001	PRIMA

JOINTS DE PORTE-FILTRES FAEMA



Photo	Code LF	Dimensions (mm)	Notes	Adaptable sur	Pour modèle machine
1	1186722	ø 73x57x8	---	FAEMA 4701016528	COMPACT - DUE - EXPRESS - E61 - E64 - E66 - E91 - E97 - E98
1	1186723	ø 73x57x8.5	---	FAEMA	COMPACT - DUE - EXPRESS - E61 - E64 - E66 - E91 - E97 - E98
1	1186724	ø 73x57x9	---	FAEMA	COMPACT - DUE - EXPRESS - E61 - E64 - E66 - E91 - E97 - E98
1	1486724	ø 73x57x10	---	FAEMA	COMPACT - DUE - EXPRESS - E61 - E64 - E66 - E91 - E97 - E98
2	1186721	ø 74x57.5x8	ENCOCHES INTERNES	FAEMA 402199010	CARISMA - EMBLEMA - ENOVA - E61 - TEOREMA
2	1186725	ø 74x57.5x8.5	ENCOCHES INTERNES	FAEMA	CARISMA - EMBLEMA - ENOVA - E61 - TEOREMA
2	5028118	ø 74x58x8	ORIGINAL / ENCOCHES INTERNES	FAEMA 402199010	CARISMA - EMBLEMA - ENOVA - E61 - TEOREMA
3	1186701	ø 71x56x9	CONIQUE	FAEMA 401261010	E98 COMPACT
3	5032979	ø 71x56x9	ORIGINAL / CONICAL	FAEMA 401261010	E98 COMPACT
4	1486040	ø 73x57x8.5	ENCOCHES INTERNES	FAEMA	COMPACT - DUE - EXPRESS - E61 - E64 - E66 - E91 - E97 - E98

MACHINES A CAFE

PIECES DETACHEES

JOINTS DE PORTE-FILTRES GAGGIA



Photo	Code LF	Dimensions (mm)	Notes	Adaptable sur	Pour modèle machine
1	1186676	ø 72x56x8.5	ENCOCHES INTERNES	GAGGIA WGANG01/001/B	DECO - D90 - E90 - FD2000 - FE2000 - GD - GE - XD - XE
1	1486041	ø 72x56x8.5	ORIGINAL	GAGGIA WGANG01/001/B	DECO - D90 - E90 - FD2000 - FE2000 - GD - GE - XD - XE
2	1186741	ø 72x56x8.5	---	GAGGIA	DECO - D90 - E90 - FD2000 - FE2000 - GD - GE - XD - XE
2	1786216	ø 72x57x8.5	---	GAGGIA NG01/001	ACHILLE - BABY - BABY86 - BABY89 - CAREZZA - CLASSIC
2	1486006	ø 73.5x57x5	---	GAGGIA GG0026/01	CUBIKA - GRANGAGGIA - VIVA-GAGGIA
3	1486003	ø 79x56x6.5	---	GAGGIA 11004543	NEWESPRESSO06
4	1186998	ø 66x36x16	---	GAGGIA 145841500	CAREZZA DELUXE - GRAN GAGGIA
5	5027216	ø 55	---	GAGGIA 145849762	CAREZZA NEW - GRAN GAGGIA

JOINTS DE PORTE-FILTRES MARZOCCO



Photo	Code LF	Dimensions (mm)	Notes	Adaptable sur	Pour modèle machine
1	1186764	ø 72x55x6	ENCOCHES EXTERNES	MARZOCCO L105/B6	FB70 - FB80 - GB5 - LINEA
1	1186765	ø 72x55x7	ENCOCHES EXTERNES	MARZOCCO L105/B7	FB70 - FB80 - GB5 - LINEA
2	1186760	ø 72x55x6.1/8	ENCOCHES EXTERNES	MARZOCCO L105/B8	FB70 - FB80 - GB5 - GS3 - LINEA - MISTRAL - STRADA
2	1186761	ø 72x55x7.1/9	ENCOCHES EXTERNES	MARZOCCO L105/B9	FB70 - FB80 - GB5 - GS3 - LINEA - MISTRAL - STRADA
3	1486001	ø 72x55x6.1/8	ENCOCHES EXTERNES	MARZOCCO L105/B8	FB70 - FB80 - GB5 - GS3 - LINEA - MISTRAL - STRADA
3	1486005	ø 72x55x7.1/9	ENCOCHES EXTERNES	MARZOCCO L105/B9	FB70 - FB80 - GB5 - GS3 - LINEA - MISTRAL - STRADA
4	5059357	ø 72x55x6.1/8	ENCOCHES EXTERNES	MARZOCCO L105/B8	FB70 - FB80 - GB5 - GS3 - LINEA - MISTRAL - STRADA
4	5059358	ø 72x55x7.1/9	ENCOCHES EXTERNES	MARZOCCO L105/B9	FB70 - FB80 - GB5 - GS3 - LINEA - MISTRAL - STRADA
5	1486042	ø 72x55x6.1/8	ENCOCHES EXTERNES	MARZOCCO L105/B8	FB70 - FB80 - GB5 - GS3 - LINEA - MISTRAL - STRADA

JOINTS DE PORTE-FILTRES RANCILIO



1

Photo	Code LF	Dimensions (mm)	Notes	Adaptable sur	Pour modèle machine
1	1186812	ø 72x57x8	ENCOCHES EXTERNES	RANCILIO 36301001	CLASSE10/9/8/7/6 - EPOCA - MILLENNIUM - S20 - Z11
1	5048248	ø 74x57.5x8.5	ENCOCHES EXTERNES	RANCILIO 36301046	CLASSE10/9/8/7/6 - EPOCA
1	1486032	ø 74x57.5x8.5	ORIGINAL / ENCOCHES EXTERNES	RANCILIO 36301046	CLASSE10/9/8/7/6 - EPOCA
1	1186452	ø 74x58x8.2	ENCOCHES EXTERNES	RANCILIO 36301030	AUDREY - NANCY - SILVIA
1	5012498	ø 74x58x8.2	ORIGINAL / ENCOCHES EXTERNES	RANCILIO 36301030	AUDREY - NANCY - SILVIA

JOINTS DE PORTE-FILTRES SAN MARCO



1

Photo	Code LF	Dimensions (mm)	Notes	Adaptable sur	Pour modèle machine
1	1186851	ø 64x52.5x5.5	ENCOCHES EXTERNES	SAN MARCO 109011	LEVA - 100 - 105 - 105 NEW - 85 - 95
1	5071882	ø 64x52.5x5.5	ORIGINAL / ENCOCHES EXTERNES	SAN MARCO 109011	LEVA - 100 - 105 - 105 NEW - 85 - 95
1	1186786	ø 64x52.5x5.5	ORIGINAL / ENCOCHES EXTERNES	SAN MARCO 109130	LEVA - 100 - 105 - 105 NEW - 85 - 95

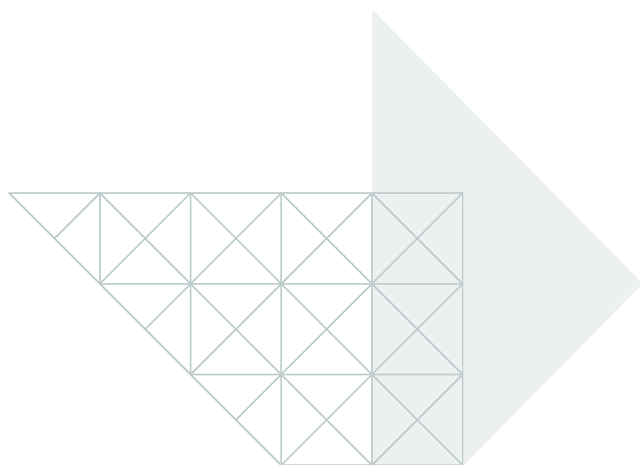

MACHINES A CAFE

PIECES DETACHEES



Code LF: 1081026

DOUCHETTE DE DISTRIBUTION ø 56.5 mm

trou central ø 5 mm

DOUCHETTES DE DISTRIBUTION ASTORIA/CMA



Photo	Code LF	Dimensions	Adaptable sur	Pour modèle machine
1	1081041	ø 48.0 mm	ASTORIA/CMA 27100001	PLUS4YOU
2	1081006	ø 51.5 mm	ASTORIA/CMA 27100	ARGENTA - BRAVA - DENISE - DIVINA - DORA - GLORIA
3	1081007	ø 51.5 mm	ASTORIA/CMA 27100	ARGENTA - BRAVA - DENISE - DIVINA - DORA - GLORIA
4	1081002	ø 51.5 mm	ASTORIA/CMA 27100	ARGENTA - BRAVA - DENISE - DIVINA - DORA - GLORIA
5	1081003	ø 57.5 mm	ASTORIA/CMA 27101	RAPALLO AL

DOUCHETTES DE DISTRIBUTION CASADIO



Photo	Code LF	Dimensions	Adaptable sur	Pour modèle machine
1	1081006	ø 51.5 mm	CASADIO 457504000	VENTI
2	1081016	ø 60.0 mm	CASADIO 457560000	DIECI - DODICI
3	1081116	ø 60.0 mm	CASADIO 457560000	DIECI - DODICI
4	1081216	ø 60.0 mm	CASADIO 457560000	DIECI - DODICI
5	1081516	ø 60.0 mm	CASADIO 457560000	DIECI - DODICI

VOIR LA LISTE COMPLETE
SUR NOTRE SITE INTERNET
WWW.EPGC.COM

MACHINES A CAFE PIECES DETACHEES

DOUCHETTES DE DISTRIBUTION CIMBALI



Photo	Code LF	Dimensions	Adaptable sur	Pour modèle machine
1	1081006	ø 51.5 mm	CIMBALI 457-504-000	JUNIOR - M21 - M24 - M27 - M28 - M30 - M31 - M32 - M39
2	1081010	ø 53.0 mm	CIMBALI 458-093-000	M20 - M21

DOUCHETTES DE DISTRIBUTION FAEMA



Photo	Code LF	Dimensions	Adaptable sur	Pour modèle machine
1	1081016	ø 60.0 mm	FAEMA 457560000	COMPACT - DUE - EMBLEMA - ENOVA - EXPRESS - E61 - E91
2	1081116	ø 60.0 mm	FAEMA 457560000	COMPACT - DUE - EMBLEMA - ENOVA - EXPRESS - E61 - E91
3	1081216	ø 60.0 mm	FAEMA 457560000	COMPACT - DUE - EMBLEMA - ENOVA - EXPRESS - E61 - E91
4	1081516	ø 60.0 mm	FAEMA 457560000	COMPACT - DUE - EMBLEMA - ENOVA - EXPRESS - E61 - E91
5	1081100	ø 60.0 mm	FAEMA	E61 - E61JUBILE

DOUCHETTES DE DISTRIBUTION GAGGIA

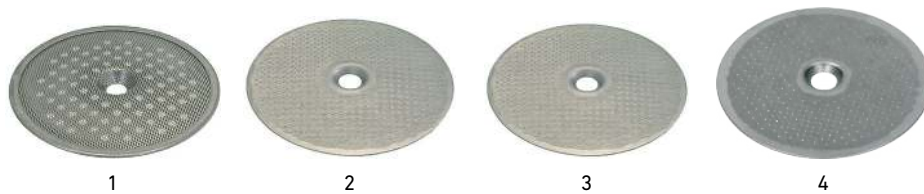

Photo	Code LF	Dimensions	Adaptable sur	Pour modèle machine
1	1081021	ø 55.0 mm	GAGGIA WGADM0269	DECO - D90 - E90 - GD - GE - LCD - TS - XD - XE
2	1081063	ø 54.5 mm	GAGGIA DM0704	BABY - CAREZZA - CLASSIC - EVOLUTION - NEWBABY
3	1081022	ø 51.5 mm	GAGGIA	BABY - NEWBABY
4	1081112	ø 49,5 mm	GAGGIA 11001471	NEW ESPRESSO 06 DOSE

MACHINES A CAFE

PIECES DETACHEES

DOUCHETTES DE DISTRIBUTION MARZOCCO



Photo	Code LF	Dimensions	Adaptable sur	Pour modèle machine
1	1081023	ø 57.5 mm	MARZOCCO L107	FB70 - FB80 - GB5 - GS3 - LINEA - MISTRAL - STRADA
2	5054756	ø 57.5 mm	MARZOCCO	FB70 - FB80 - GB5 - GS3 - LINEA - MISTRAL - STRADA
3	1081117	ø 57.5 mm	MARZOCCO F.3.040.01	GS3 - LINEA PB - MINI - GB5 - FB80

DOUCHETTES DE DISTRIBUTION SPAZIALE



Photo	Code LF	Dimensions	Adaptable sur	Pour modèle machine	Notes
1	1081046	ø 49/52 mm	SPAZIALE 2908+2909	PROFESSIONAL - S1 - S3 - SPAZIO - NEW - S40 - S5	MADE IN ITALY
2	1081128	ø 49/52 mm	SPAZIALE 2908+2909	PROFESSIONAL - S1 - S3 - SPAZIO - NEW - S40 - S5	MADE OUTSIDE THE UE



Code LF: 3526704

ROBINET A BILLE ø 3/8"MF



Code LF: 1251706

COUPLE MEULES CIMBALI-FAEMA CONIQUE DROITE

MEULES "FOOD FRIENDLY"
durée améliorée de 70%
par rapport à des meules standards
ne subit de déformations
contamination mineure du café moulu
ø ext. 68/49 mm - ø int. 40/11 mm
épaisseur 25 mm - 4 trous fixation



Code LF: 1251929

COUPLE MEULES MAZZER MONOPHASE DROITE

ø ext. 64 mm - ø int. 37 mm
épaisseur 8,4 mm - 3 axes de fixation

MACHINES A CAFE PIECES DETACHEES

DEBITMETRES VOLUMETRIQUES GICAR



1 - 1/4



2 - 1/8



3 - 1/4



4 - 1/4



5 - 1/4



6 - 1/4

Ph.	Code LF	Modèle	Adaptable sur	Pour modèle machine
1	1455067	9.0.55.02G / ø 1/4"FF / ø 1.15 mm	ASTORIA/CMA 18126	ARGENTA - BRAVA - DIVINA - DORA - GLORIA - GLORIA R12
1	1455067	9.0.55.02G / ø 1/4"FF / ø 1.15 mm	BEZZERA 7431001	B2000 - B2006 - B2009 COMPACT - B2013 - B3000 - B4000
1	1455067	9.0.55.02G / ø 1/4"FF / ø 1.15 mm	BFC 5032012	CLASSICA - DELUX - GALILEO - GRANDOGO - IMOLA - JUNIOR
1	1455067	9.0.55.02G / ø 1/4"FF / ø 1.15 mm	BRUGNETTI-AURORA 95.01205	---
1	1455067	9.0.55.02G / ø 1/4"FF / ø 1.15 mm	CARIMALI 95.01115	CENTO50, E9, ETA BETA, KIKKO
1	1455005	9.0.78.02G / ø 1/4"FF / ø 1.15 mm	CONTI 403466V	SK2
1	1455067	9.0.78.02G / ø 1/4"FF / ø 1.15 mm	ELEKTRA 02429035	CLASSIC - KAPPA - MODERN - SIXTIES
1	1455067	9.0.55.02G / ø 1/4"FF / ø 1.15 mm	EXPOBAR 60100045	ELEN - EXPRESSO - G10 - MARKUS - MARKUS SILVER
1	1455077	9.0.33.02G / ø 1/4"FF / ø 1.15 mm	EXPOBAR 60100045	CARAT - DIAMANT - ELEN - G10 - MARCUS - ONYX - ROSETTA
1	1455067	9.0.55.02G / ø 1/4"FF / ø 1.15 mm	FIorenzato CS A1500026	BRICOLETTA - DUCALE - FENICE - LIDO - VENEZIA
1	1455067	9.0.55.02G / ø 1/4"FF / ø 1.15 mm	FUTURA 400028	F100
1	1455067	9.0.55.02G / ø 1/4"FF / ø 1.15 mm	FUTURMAT 08307500	ARIETE - F3 - RIMINI
1	1455060	9.0.93.02G / ø 1/4"FF / ø 1.15 mm	GAGGIA 11013052	DECO - GD - GE - XD - XE
1	1455067	9.0.55.02G / ø 1/4"FF / ø 1.15 mm	GRIMAC 1160900001-GR102	MIA - NEW CIALDA VAPOR - SELENITE DOUBLE - TWENTY
1	1455067	9.0.55.02G / ø 1/4"FF / ø 1.15 mm	LAVAZZA 10066245	LB4700
1	1455067	9.0.55.02G / ø 1/4"FF / ø 1.15 mm	MCE 18126	START
1	1455067	9.0.55.02G / ø 1/4"FF / ø 1.15 mm	NUOVA SIMONELLI 04900027	APPIA - APPIA COMPACT - AURELIA - AURELIAII - MACDIGIT
1	1455067	9.0.55.02G / ø 1/4"FF / ø 1.15 mm	ORCHESTRALE D18126	ETNICA - PHONICA
1	1455067	9.0.55.02G / ø 1/4"FF / ø 1.15 mm	RENEKA 9008954	LC - LIFE - PRESTIGE - VIVA
1	1455080	9.0.25.08G / ø 1/4"FF / ø 1.15 mm	RENEKA 9008954	LC - LIFE - PRESTIGE - VIVA
1	1455067	9.0.55.02G / ø 1/4"FF / ø 1.15 mm	ROYAL 5032012	DIADEMA - SYNCHRO
1	1455060	9.0.93.02G / ø 1/4"FF / ø 1.15 mm	SAECO 11013052	AROMA
1	1455067	9.0.55.02G / ø 1/4"FF / ø 1.15 mm	SAN MARCO 108192	NEW 105 - 100 - 105 - 85 - 95
1	1455067	9.0.55.02G / ø 1/4"FF / ø 1.15 mm	SANREMO 10112131A	MILANO LX
1	1455081	9.0.25.40G / ø 1/4"FF / ø 1.15 mm	SANREMO 10112282B	OPERA - VERONA RS - ZOE COMPACT
1	1455067	9.0.55.02G / ø 1/4"FF / ø 1.15 mm	SCALA C-0215	BUTTERFLY - CARMEN - EROICA
1	1455067	9.0.55.02G / ø 1/4"FF / ø 1.15 mm	VIBIEMME ELETCONTVOLOT	CHIMAERA - CUBO - DOMOBARSUPER - DOSAPLUS - EVOLUTION
1	1455067	9.0.55.02G / ø 1/4"FF / ø 1.15 mm	VICTORIA ARDUINO 04900027	ADONIS - VENUS CENTURY
1	1455067	9.0.55.02G / ø 1/4"FF / ø 1.15 mm	WEGA WY18126	ATLAS - ATLAS 10 - COLOSSEUM - COMBI NOVA - CONCEPT
2	1455068	9.0.55.50G / ø 1/8"FF / ø 1.15 mm	BRASILIA 16054.2.00.08	ROMA
2	1455068	9.0.55.50G / ø 1/8"FF / ø 1.15 mm	CIMBALI 534-391-020	M20 - M21 JUNIOR - M22 - M27 - M27 START - M28 - M29
2	1455068	9.0.55.50G / ø 1/8"FF / ø 1.15 mm	FAEMA 534391020	E98 COMPACT
2	1455068	9.0.55.50G / ø 1/8"FF / ø 1.15 mm	FIAMMA RST 5.0.000.1012	ATLANTIC - MARINA - PRESTIGE
2	1455068	9.0.55.50G / ø 1/8"FF / ø 1.15 mm	PAVONI 438020	---
2	1455068	9.0.55.50G / ø 1/8"FF / ø 1.15 mm	SANREMO 10112290	AMALFI - CAPRI - PISA - TORINO - VERONA - ZOE
3	1455026	9.0.54.05G / ø 1/4"FF / ø 1.15 mm	FRACINO FC92	BAMBINO
3	1455026	9.0.54.05G / ø 1/4"FF / ø 1.15 mm	MARZOCCO LAD070	FB70 - FB80 - GB5 - GS3 - LINEA - MISTRAL
3	5091964	9.0.24.12G / ø 1/4"FF / ø 1.15 mm	MARZOCCO LAD070	FB70 - FB80 - GB5 - GS3 - LINEA - MISTRAL
3	1455026	9.0.54.05G / ø 1/4"FF / ø 1.15 mm	PROMAC 34070050	CLUB - COMPACT - GREEN
3	1455026	9.0.54.05G / ø 1/4"FF / ø 1.15 mm	RANCILIO 34070050	CLASSE10 - CLASSE9 - EPOCA
4	1455074	9.0.25.20G / ø 1/4"FF / ø 1.15 mm	RANCILIO 10705240	CLASSE5 USB
4	1455074	9.0.25.20G / ø 1/4"FF / ø 1.15 mm	PROMAC 34070052	CLUB - COMPACT - GREEN
5	1455076	9.0.75.96G / ø 1/4"FF / ø 1.15 mm	SPAZIALE 02498	NEW - RAPID - S1 - S2 - S3 - S40 - S5 - S8
6	1455001	9.0.69.03G / ø 1/4"FF / ø 1.15 mm	SPAZIALE 02498	NEW - RAPID - S1 - S2 - S3 - S40 - S5 - S8

MACHINES A CAFE

PIECES DETACHEES

POMPES VOLUMETRIQUES NUERT



Photo	Code LF	Débit (L/h)	raccords (ø)	Adaptable sur
1	1330203	50	3/8"	TOUTES MARQUES
1	1330206	200	3/8"	TOUTES MARQUES
1	1330201	100	3/8" NPT	TOUTES MARQUES
1	1330202	200	3/8" NPT	TOUTES MARQUES
1	1330900	200	3/8"	RANCILIO 10705960
2	1330205	100	3/8"	TOUTES MARQUES
2	1330204	200	3/8"	TOUTES MARQUES
3	1330200	150	3/8"	CASADIO - CIMBALI - FAEMA
4	1330218	180	3/8"	CASADIO - CIMBALI - FAEMA

POMPES VOLUMETRIQUES PROCON



Photo	Code LF	Débit (L/h)	raccords (ø)	Adaptable sur
1	1330012	180	3/8" NPT	TOUTES MARQUES
1	1330024	100	3/8" NPT	PAVONI
1	1330019	100	3/8" NPT	CIMBALI - FAEMA - SPAZIALE
2	1330016	200	3/8" NPT	TOUTES MARQUES
3	1330033	180	3/8" NPT	CASADIO - CIMBALI - FAEMA
4	1330011	200	3/8" NPT	FAEMA
5	1330017	150	3/8" NPT	CASADIO - CIMBALI - FAEMA

VOIR LA LISTE COMPLETE
SUR NOTRE SITE INTERNET
WWW.EPGC.COM

MACHINES A CAFE PIECES DETACHEES

POMPES VOLUMETRIQUES ROTOFLOW



Photo	Code LF	Débit (L/h)	raccords (ø)	Adaptable sur
1	1330021	50	3/8"	TOUTES MARQUES
1	1330035	100	3/8"	TOUTES MARQUES
1	1330008	150	3/8"	TOUTES MARQUES
1	1330026	200	3/8"	TOUTES MARQUES
1	1330001	100	3/8" NPT	TOUTES MARQUES
1	1330029	150	3/8" NPT	TOUTES MARQUES
1	1330002	200	3/8" NPT	TOUTES MARQUES
1	1330101	100	3/8" NPT ECO BRASS	TOUTES MARQUES
1	1330102	200	3/8" NPT ECO BRASS	TOUTES MARQUES
1	1330030	200	3/8"	RANCILIO 10705960
2	1330025	70	3/8"	TOUTES MARQUES
2	1330038	100	3/8"	TOUTES MARQUES
2	1330004	100	3/8" NPT	TOUTES MARQUES
2	5031943	200	3/8" NPT	TOUTES MARQUES
3	1330022	50	3/8"	TOUTES MARQUES
3	1330005	100	3/8"	TOUTES MARQUES
3	1330122	50	3/8" ECO BRASS	TOUTES MARQUES
4	1330031	150	3/8"	CASADIO - CIMBALI - FAEMA
5	1330003	200	3/8" NPT	FAEMA - GRIMAC
6	1330006	200	3/8"	UNIC

SONDES DE NIVEAU



Photo	Code LF	Notes
1	1430006	1/4"M-80 mm
1	5030757	1/4"M-100 mm
1	1341750	1/4"M-125 mm
1	3341011	1/4"M-140 mm
1	1341751	1/4"M-150 mm
1	5067637	1/4"M-167 mm
1	1341315	1/4"M-255 mm
2	3341069	1/4"M-75 mm
2	1341001	1/4"M-125 mm
2	1341752	1/4"M-148 mm

MACHINES A CAFE PIECES DETACHEES

PRESSOSTATS SIRAI



Photo	Code LF	Modèle	Echelle (bar)
1	1320531	P302/6 - 3 POLES - 30A - 1/4"	0.5 à 1.4
2	1320533	P302/6	---
3	1320800	P203T01 - 2 POLES - 20A - 1/4"	0.5 à 1.4
3	1320801	P203T02 - 2 POLES - 20A - 1/4"	0.9 à 1.7
3	1320802	P303T01 - 3 POLES - 20A - 1/4"	0.5 à 1.4
3	1320803	P303T02 - 3 POLES - 20A - 1/4"	0.9 à 1.7

ELECTROVANNES LUCIFER 2 VOIES



Photo	Code LF	raccords (ø)	Orifice (ø)	Etanchéité	Modèle	Type bobine	Adaptable sur
1	1120331	---	3.5	RUBIS	121FS1651A	9W 220/240V 50/60Hz	TOUTES MARQUES
2	1120460	1/8	2.5	VITON	7121ZBG1LV00	9W 220/240V 50/60Hz	TOUTES MARQUES
2	1120466	1/8	2.5	VITON	7121ZBG1LV00	9W 110/115/120V 50/60Hz	TOUTES MARQUES
2	1120461	1/8	2.5	RUBIS	7121ZBG1LR00	9W 220/240V 50/60Hz	TOUTES MARQUES
3	1120371	---	1.5	RUBIS	121F4417	9W 220/240V 50/60Hz	CASADIO 533898300R
3	1120371	---	1.5	RUBIS	121F4417	9W 220/240V 50/60Hz	CIMBALI 533-898-300R
3	1120371	---	1.5	RUBIS	121F4417	9W 220/240V 50/60Hz	FAEMA 533898300R
3	1120241	---	1.5	RUBIS	121F4417	9W 24VAC 50/60Hz	CIMBALI 533-893-300R
3	1120241	---	1.5	RUBIS	121F4417	9W 24VAC 50/60Hz	FAEMA 533893300R
4	1120356	1/8	2.5	VITON	121ZS1692	9W 220/240V 50/60Hz	ASTORIA CMA 4918162005
4	1120356	1/8	2.5	VITON	121ZS1692	9W 220/240V 50/60Hz	WEGA WY4618162005
4	1120290	1/8	2.5	VITON	7121ZBG1LV00	9W 24VAC 50/60Hz	CIMBALI 533-895-100R
4	1120290	1/8	2.5	VITON	7121ZBG1LV00	9W 24VAC 50/60Hz	FAEMA 533895100R

MACHINES A CAFE PIECES DETACHEES

ELECTROVANNES PARKER 2 VOIES



1



2



3



4



5



6

Photo	Code LF	raccords (ø)	Orifice (ø)	Etanchéité	Modèle	Type bobine	Adaptable sur
1	1120352	---	2.5	VITON	VE125CV2	9W 220/230V 50/60Hz	TOUTES MARQUES
1	1120154	---	2.5	VITON	VE125CV2	9W 110/120V 50/60Hz	TOUTES MARQUES
2	1120700	1/8	2.5	VITON	VE146FV	9W 220/230V 50/60Hz	TOUTES MARQUES
2	1120155	1/8	2.5	VITON	VE146V	9W 110/120V 50/60Hz	TOUTES MARQUES
2	1120151	1/8	3.0	VITON	VE146HV	9W 110/120V 50/60Hz	TOUTES MARQUES
2	1120354	1/4	2.5	VITON	VE146NV	9W 220/230V 50/60Hz	TOUTES MARQUES
2	1120153	1/4	3.0	VITON	VE146YV	9W 110/120V 50/60Hz	TOUTES MARQUES
2	1120348	1/4	3.0	VITON	VE146V	9W 220/230V 50/60Hz	SPAZIALE 06478
2	1120259	1/4	4.5	VITON	VE146.3KV	14W 220/230V 50/60Hz	VIBIEMME ELETELE2A2245
3	1120355	1/8	2.5	RUBIS	VE1402IR	9W 220/230V 50/60Hz	TOUTES MARQUES
3	5019235	1/8	2.5	VITON	7121Z	9W 24VAC 50/60Hz	CIMBALI 533-798-400
3	5019235	1/8	2.5	VITON	7121Z	9W 24VAC 50/60Hz	FAEMA 533798400
4	2101493	1/8	4.0	VITON	VE131	9W 220/230V 50/60Hz	FRACINO FC171
4	1120246	1/4	2.2	VITON	VE161.4EV	9W 220/230V 50/60Hz	BIANCHI 25034216
4	1120246	1/4	2.2	VITON	VE161.4EV	9W 220/230V 50/60Hz	LAVAZZA 10084193
4	1120048	1/4	2.0	VITON	VE161.4QVFOV	9W 220/230V 50Hz	EXPOBAR 60000100
5	1120010	1/8	1.5	VITON	121KH1465	9W 220/230V 50/60Hz	SPAZIALE 00907
5	1120010	1/8	1.5	VITON	121KH1465	9W 220/230V 50/60Hz	CIME DPRKELE05
5	1120386	1/8	1.5	VITON	201XGRAGV7	9W 220/230V 50/60Hz	SANREMO 10303107
6	5019884	---	2.0	VITON	175BV	6W 220/230V 50/60Hz	SANREMO 10303080

VOIR LA LISTE COMPLETE
SUR NOTRE SITE INTERNET
WWW.EPGC.COM

MACHINES A CAFE

PIECES DETACHEES

ELECTROVANNES LUCIFER 3 VOIES



1



2



3



4

Photo	Code LF	raccords (ø)	Orifice (ø)	Etanchéité	Sortie (ø)	Modèle	Type bobine	Adaptable sur
1	1120330	---	1.5	RUBIS	1/8 CONIQUE	E131F4304	9W 220/240V 50/60Hz	TOUTES MARQUES
1	1120102	---	1.5	RUBIS	1/8 CONIQUE	E131F4304	9W 110/115/120V 50/60Hz	TOUTES MARQUES
1	5069161	---	1.5	RUBIS	1/8 CONIQUE	E131F4304	9W 24VAC 50/60Hz	TOUTES MARQUES
1	1120357	---	2.5	RUBIS	1/8 CONIQUE	E131F4304	9W 24VDC	RANCILIO 34040024
2	1120373	---	1.5	RUBIS	1/8 CONIQUE	E131F4304	9W 220/240V 50/60Hz	CASADIO 533894600R
2	1120373	---	1.5	RUBIS	1/8 CONIQUE	E131F4304	9W 220/240V 50/60Hz	CIMBALI 533-894-600R
2	1120373	---	1.5	RUBIS	1/8 CONIQUE	E131F4304	9W 220/240V 50/60Hz	FAEMA 533894600R
2	5035034	---	1.5	RUBIS	1/8 CONIQUE	E131F4304G	9W 24VAC 50/60Hz	CIMBALI 533-894-500R
2	5035034	---	1.5	RUBIS	1/8 CONIQUE	E131F4304G	9W 24VAC 50/60Hz	FAEMA 533894500R
3	1120378	1/8	3.0	VITON	1/8 CONIQUE	131KSG004	9W 220/240V 50/60Hz	CASADIO 533895800R
3	1120378	1/8	3.0	VITON	1/8 CONIQUE	131KSG004	9W 220/240V 50/60Hz	FAEMA 533895800R
3	5030839	1/8	3.0	VITON	1/8 CONIQUE	131K6304	13W 24VAC 60Hz	CIMBALI 533-890-910R
3	5030839	1/8	3.0	VITON	1/8 CONIQUE	131K6304	13W 24VAC 60Hz	FAEMA 533890910R
3	1120379	1/8	3.0	---	1/8 CONIQUE	141.2YVA.5	9W 220/230V 50/60Hz	EXPOBAR 60000120
4	1120334	---	1.5	RUBIS	1/8 CONIQUE	E131F4304	---	TOUTES MARQUES

ELECTROVANNES PARKER 3 VOIES



1



2



3



4

Photo	Code LF	raccords (ø)	Orifice (ø)	Etanchéité	Sortie (ø)	Modèle	Type bobine	Adaptable sur
1	1120335	---	1.3	RUBIS	1/8 CONIQUE	VE128IR	9W 220/230V 50/60Hz	TOUTES MARQUES
1	1120350	---	1.3	RUBIS	1/8 CONIQUE	VE128IR	9W 24VAC 50/60Hz	TOUTES MARQUES
1	1120101	---	1.3	RUBIS	1/8 CONIQUE	VE128IR	9W 110/120V 50/60Hz	TOUTES MARQUES
2	1120351	---	1.3	RUBIS	1/8	VE128GR	9W 220/230V 50/60Hz	BRASILIA - GAGGIA
3	1120339	---	1.3	RUBIS	1/8 CONIQUE	VE128IR	---	TOUTES MARQUES
3	1120439	---	1.3	VITON	1/8 CONIQUE	PM128IV	---	TOUTES MARQUES
4	1120265	---	1.3	RUBIS	1/8	VE128GR	---	BRASILIA - GAGGIA

MACHINES A CAFE PIECES DETACHEES

ELECTROVANNES ODE 3 VOIES



1



2



3



4



5

Photo	Code LF	raccords (ø)	Orifice (ø)	Etancheité	Sortie (ø)	Modèle	Type bobine	Adaptable sur
1	5083411	---	1.5	RUBIS	6.6	31A1BHL1R15-VOT3	14,5VA 24VAC 50/60Hz	DALLA CORTE B-00-0025
1	1120225	---	1.1	RUBIS	6.6	31A1BHL1R11-T3	11W 24VDC	SAECO 11012534
2	1120123	1/8	1.1	VITON	6.6	31A3HLV11	8W 220/230V 50/60Hz	SAECO 9121.138.00A
2	1120180	1/8	1.1	VITON	6.6	31A3HLV11-PB	8W 24VDC	SAECO 9121.138.00P
3	1120166	1/8	1.0	VITON	6.6	316A3HV10-X020	8W 220/230V 50/60Hz	LAVAZZA 10063970
4	1120276	1/8	2.0	VITON	6.6	31JN1XRV20-SXT	7W 24VDC	SAECO 11024039
4	5020858	1/8	2.3	VITON	6.6	31JN1XPV23	11,5VA 230/240V 50/60Hz	SIMONELLI 04100054
5	5093110	---	1.5	RUBIS	1/8 CONIQUE	4767A1R15-VT3	16VA 230/240V 50/60Hz	MARZOCCO B.2.004.02

INTERRUPTEURS "UNIVERSELS"



1



2



3



4

Photo	Code LF	Notes
1	3319019	INTERRUPTEUR / 16A 250V
2	3319029	INTERRUPTEUR / 16A 250V
3	3319035	INTERRUPTEUR / 16A 250V
4	3319251	INTERRUPTEUR / 16A 250V



Code LF: 1319582

CLAVIER DE COMMANDE 5 TOUCHES

230V 50/60Hz

VOIR LA LISTE COMPLETE
SUR NOTRE SITE INTERNET
WWW.EPGC.COM

MACHINES A CAFE

PIECES DETACHEES

POMPES VIBRANTES ULKA

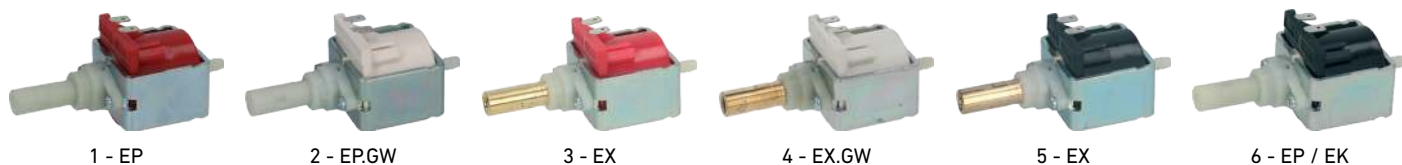

Photo	Code LF	Modèle	Watt - Volt	Raccords
1	1331018	EP4	48W 230V 50Hz	ø 1/8" - ø 6 mm
1	1122738	EP5	48W 24V 50/60Hz	ø 1/8" - ø 6 mm
1	1122737	EP5	48W 230V 50Hz	ø 1/8" - ø 6 mm
1	1331054	EP7	48W 230V 50Hz	ø 1/8" - ø 6 mm
1	1331037	EP8	26W 230/240V 50Hz	ø 1/8" - ø 6 mm
2	1122002	EP5GW	48W 230V 50Hz	ø 1/8" - ø 6 mm
2	1331026	EP5GW	48W 230V 50Hz	évasé ø 1/8" - ø 6 mm
2	1331028	EP8GW	26W 230V 50Hz	ø 1/8" - ø 6 mm
3	1122746	EX4	48W 230V 50Hz	ø 1/8" - ø 6 mm
3	1122747	EX4	48W 24V 50/60Hz	ø 1/8" - ø 6 mm
3	1122735	EX5	48W 230V 50Hz	ø 1/8" - ø 6 mm
3	1122739	EX5	48W 230V 50Hz	évasé ø 1/8" - ø 6 mm
3	1122736	EX5	48W 24V 50/60Hz	ø 1/8" - ø 6 mm
3	1122740	EX5	48W 24V 50/60Hz	évasé ø 1/8" - ø 6 mm
3	1331036	EX7	48W 24V 50/60Hz	ø 1/8" - ø 6 mm
3	1120025	EX7	48W 230V 50Hz	ø 1/8" - ø 6 mm
4	1331029	EX4GW	48W 230V 50Hz	ø 1/8" - ø 6 mm
4	1331006	EX5GW	48W 230V 50Hz	ø 1/8" - ø 6 mm
4	1331016	EX7GW	48W 230V 50Hz	ø 1/8" - ø 6 mm
5	1122601	EX5	41W 120V 60Hz	ø 1/8" - ø 6 mm
5	1122604	EAX4	52W 120V 60Hz	ø 1/8" - ø 6 mm
5	2101958	EAX5	52W 120V 60Hz	ø 1/8" - ø 6 mm
5	5062745	EAX5	64W 220V 60Hz	ø 1/8" - ø 6 mm
6	2102265	EP5	41W 120V 60Hz	ø 1/8" - ø 6 mm
6	5062552	EAP5	52W 120V 60Hz	ø 1/8" - ø 6 mm
6	1122748	EK	54W 230V 50Hz	ø 1/8" - ø 6 mm

VOIR LA LISTE COMPLETE
SUR NOTRE SITE INTERNET
WWW.EPGC.COM

MACHINES A CAFE TRAITEMENT DE L'EAU

FILTRES BRITA



LF Code	Modèle	Dimensions	température de l'eau	Capacité à 10°KH	Pression d'utilisation	Débit
7151296	C 1100	ø 184x554 mm	4 à 30°C	11500 L	2 à 8.6 bar	120 L/h
3010607	C 500	ø 149x554 mm	4 à 30°C	6800 L	2 à 8.6 bar	120 L/h
3010606	C 300	ø 124x476 mm	4 à 30°C	4000 L	2 à 8.6 bar	60 L/h
3010605	C 150	ø 117x421 mm	4 à 30°C	2408 L	2 à 8.6 bar	60 L/h
3010608	C 50	ø 117x267 mm	4 à 30°C	960 L	2 à 8.6 bar	60 L/h
3010609	C 25	ø 117x267 mm	4 à 30°C	352 L	2 à 8.6 bar	30 L/h
3010617	C 500	---	---	---	---	---
3010616	C 300	---	---	---	---	---
3010615	C 150	---	---	---	---	---
3010618	C 50	---	---	---	---	---
3010619	C 25	---	---	---	---	---



LF Code: 3010267



LF Code: 3010300



LF Code: 3010322

RESINE 25 L

conditionnement de 25 L

SEL EN PASTILLES 25 kg

pour installation d'adoucissement de l'eau

SEL SANITAIRE EN PASTILLES 8 kg

agit contre les proliférations bactériennes pendant la période d'arrêt
action: il suffit de remplacer le sel habituel avec le paquet Sanitabs de 8 kg dans le conteneur, en faisant quelques cycles de régénération et assurant ainsi l'hygiène de l'adoucisseur



LF Code: 1394015



LF Code: 1394014

TESTEUR ELECTRONIQUE DE pH

mesure l'ACIDITE (pH)
modèle: 5305
avec fonction thermomètre
plage de mesure: 0-14pH / 0-50 °C
dimensions: 190x38 mm
avec étui

TESTEUR ELECTRONIQUE DE TDS

mesure le TAUX SEDIMENTS DISSOUS (TDS)
modèle: TDS-3
avec fonction thermomètre
plage de mesure: 0-9990 ppm / 0-80 °C
dimensions 155x31x23 mm
avec étui

MACHINES A CAFE CONSOMMABLES



Code LF: 3168112

COLLIER NOIR
2,5x100 mm - 100 Pcs



Code LF: 5035467

COLLIER DE SERRAGE A CLIPS
ø 7,8/9,5 mm

acier inox W4



Code LF: 3449462

COLLIER DE SERRAGE
12-20

pour tuyau ø 12 à 20 mm
en acier inox AISI 304
hauteur 9 mm et vis E7
pour industrie alimentaire



Code LF: 3168106

COLLIER BLANC
3,5x140 mm - 100 Pcs



Code LF: 1449671

TUYAU DE VIDANGE ELISPIR
ø 14x20 mm - 5 m

alimentaire



Code LF: 1449876

FLEXIBLE DE VIDANGE
ø 3/4" F 1500 mm

ø ext. 20 mm - ø int. 13 mm



Code LF: 3050652

CABLE HAUTE TEMPERATURE
2,5 mm² - 10 m

silicone rubber
with glass braiding sheathing
temperature -50°C+180°C
for 100 m rolls see 3050052



Code LF: 3050657

CABLE EN NICKEL
2,5 mm² - 10 m

température -60°C+250°C
par rouleau de 100 m voir 3050057



Code LF: 3050663

CABLE CAOUTCHOUC 3 FILS
1,5 mm² - 10 m

température -25°+60°C
par rouleau de 100 m voir 3050063



Code LF: 3050189

BOITE DE DERIVATION
90x90x50 mm

IP55-IK07



Code LF: 3050218

PRISE TRIPHASEE 3 POLES + N + T
IP44

380/415V 16A

VOIR LA LISTE COMPLETE
SUR NOTRE SITE INTERNET
WWW.EPGC.COM

MACHINES A CAFE CONSOMMABLES

CONDENSATEURS POUR MOTEURS ASYNCHRONES MONOPHASES AVEC COSSES 6,3 mm



Voltage:
400V ~ 10000h B
450V ~ 3000h C



MLR 25 ECOFILL WB40

EN 60252-1



Code LF	Code GEV	µF	ø x H (mm)
3068091	LF3068091	1	30x51
3068092	LF3068092	1.5	30x51
3068135	LF3068135	2	30x51
3068093	LF3068093	2.5	30x51
3068313	LF3068313	3	30x51
3068136	LF3068136	3.15	30x51
3068077	LF3068077	3.5	30x51
3068095	LF3068095	4	30x51
3068137	LF3068137	4.5	30x51
3068096	LF3068096	5	30x51
3068078	LF3068078	6	30x51
3068097	LF3068097	6.3	30x51
3068138	LF3068138	7	30x51
3068079	LF3068079	8	30x71
3068149	LF3068149	9	30x71
3068080	LF3068080	10	30x71
3068139	LF3068139	11	30x71
3068152	LF3068152	12	35x71
3068081	LF3068081	12.5	35x71
3068082	LF3068082	14	35x71
3068140	LF3068140	15	35x71
3068083	LF3068083	16	35x71
3068141	LF3068141	18	40x71
3068084	LF3068084	20	40x71
3068085	LF3068085	22	40x71
3068086	365224	25	45x71
3068071	LF3068071	30	45x71
3068150	LF3068150	31.5	45x91
3068087	365225	35	45x91
3068142	LF3068142	40	45x91
3068088	LF3068088	45	45x116
3068072	LF3068072	50	45x116
3068089	LF3068089	55	45x116
3068090	LF3068090	60	45x116
3068073	LF3068073	65	50x116
3068074	LF3068074	70	50x116
3068075	LF3068075	80	55x116
3068076	LF3068076	90	55x116
3068151	LF3068151	100	55x116

Tolérance de capacité ±5% Fréquence 50/60Hz Coude M8

MACHINES A CAFE CONSOMMABLES

KIT DE FUSIBLES



1



2



3



4

Photo	Code LF	Code GEV	Notes	Données électriques
1	7150437	LF7150437	FUSIBLES RAPIDES / 5x20 mm / 250V	160mA-630mA-1A-1.25A-1.6A-2A-2.5A-3.15A-4A-5A-6.3A (10x)
2	7150436	LF7150436	FUSIBLES RAPIDES / 6.35x32 mm / 250V	1A-1.25A-1.6A-2A-2.5A-3.15A-4A-5A-6.3A-8A (10x)
3	7150438	LF7150438	FUSIBLES TEMPORISES / 5x20 mm / 250V	160mA-630mA-1A-1.25A-1.6A-2A-2.5A-3.15A-4A-5A-6.3A (10x)
4	3049088	LF3049088	FUSIBLES TEMPORISES / 6.35x32 mm / 250V	1A-1.25A-1.6A-2A-2.5A-3.15A-4A-5A-6.3A-8A (10x)



Code LF: 3180151



Code LF: 3180071



Code LF: 3180157

ISOLANT RACCORDS LOX1810 75 ml

adhésif anaérobie pour l'étanchéité les jonctions - raccords filetés convient pour l'étanchéité gaz, GP, air comprimé, huile, carburant et eau température d'utilisation -55 à +150°C approuvé pour l'eau potable



Code LF: 3092158

SILICONE TRANSLUCIDE GEB 310 ml

température d'utilisation -50+230°C pour collage sur supports en verre et en métal

BOBINE DE CHANVRE FIN 80 g

COLLE LOCTITE 401 - 20 g

cyanoacrylate éthylique faible viscosité - incolore température d'utilisation -40° à +120°C temps de prise 3 à 10 sec. multi-usages (métaux, plastiques et élastomères)



Code LF: 3180152

BLOQUE FILETS LOCTITE 243 - 10 ml

ester diméthacrylate moyenne viscosité thixotrope - liquide bleu empêche le desserrage des parties en vibration pour tous les raccords filetés métalliques temps de fixation acier 10 min - laiton 5 min. température d'utilisation -55+180°C

TUYAUX EN SILICONE TRANSPARENT



Code LF	ø (mm)	Longueur (mm)
1449680	3x5	10
1449280	3x5	100
1449679	3.5x6	10
1449279	3.5x6	100
1449681	4x7	5
1449281	4x7	100
1449682	5x8	10
1449282	5x8	100
1449683	5x10	10
1449283	5x10	100
1449684	6x8	10
1449284	6x8	100
1449685	6x10	5
1449285	6x10	100
1449686	6x12	10
1449687	8x10	10
1449688	8x14	10
1449689	10x13	10
1449690	12x15	10
1449691	12x18	5

pour usage alimentaire

MACHINES A CAFE CONSOMMABLES

FLEXIBLES DE REMPLISSAGE INOX RACCORDS CONIQUES



Photo	Code LF	Code GEV	Raccords	Longueur (mm)	ø interne (mm)	Température max. (°C)	Pression max (bar)
1	1449706	520616	1/8"F - 1/8"F	370	6	90	10
1	1449707	520617	1/8"F - 1/8"F	1500	6	90	10
1	1449249	LF1449249	1/4"F - 1/4"F (ACS)	190	8	90	10
1	1449269	LF1449269	1/4"F - 1/4"F (NSF)	280	6	90	10
1	5019507	LF5019507	1/4"F - 1/4"F	300	8	90	10
1	1449238		1/4"F - 1/4"F (NSF)	320	6	90	10
1	1449239	LF1449239	1/4"F - 1/4"F	325	6	90	10
1	5014643	LF5014643	1/4"F - 1/4"F	450	6	90	10
1	5025958	S0009252	1/4"F - 1/4"F	500	6	90	10
2	5024776	LF5024776	3/8"F - 1/4"F (NSF)	250	8	90	10
2	1449275	LF1449275	3/8"F - 3/8"F (NSF)	330	8	90	10
2	1449241		3/8"F - 3/8"F (ACS)	450	8	90	10
2	1449276	LF1449276	3/8"F - 3/8"F (NSF)	450	8	90	10
2	1449293	LF1449293	3/8"F - 3/8"F (NSF)	450	8	90	10
2	1449722	520572	3/8"F - 3/8"F	500	8	90	10
2	1449277	LF1449277	3/8"F - 3/8"F (NSF)	530	8	90	10
2	1449278	LF1449278	3/8"F - 3/8"F (NSF)	630	8	90	10
2	1449242	LF1449242	3/8"F - 3/8"F (ACS)	700	8	90	10
2	1449237	LF1449237	3/8"F - 3/8"F (NSF)	710	8	90	10
2	1449705	520600	3/8"F - 3/8"F	750	8	90	10
2	1449226	LF1449226	3/8"F - 3/8"F (NSF)	800	8	90	10
2	1449723	520601	3/8"F - 3/8"F	1000	8	90	10
2	1449229	LF1449229	3/8"F - 3/8"F (NSF)	1000	8	90	10
2	1449230	LF1449230	3/8"F - 3/8"F (NSF)	1200	8	90	10
2	1449725	520602	3/8"F - 3/8"F	1500	8	90	10
2	1449243	S0045141	3/8"F - 3/8"F (ACS)	1500	8	90	10
2	1449292	LF1449292	3/8"F - 3/8"F (NSF)	1500	8	90	10
2	1449218	520603	3/8"F - 3/8"F	2000	8	90	10
2	1449260		3/8"F - 3/8"F (NSF)	2300	8	90	10
2	1449261	LF1449261	3/8"F - 3/8"F (NSF)	2800	8	90	10
3	1449244	LF1449244	3/8"F - 3/8"F (ACS)	250	8	90	10
3	1449245	LF1449245	3/8"F - 3/8"F (ACS)	310	8	90	10
3	1449233	LF1449233	3/8"F - 3/8"F (NSF)	385	8	90	10
3	1449266	LF1449266	3/8"F - 3/8"F	385	8	90	10
3	1449732	520604	3/8"F - 3/8"F	500	8	90	10
3	1449234	LF1449234	3/8"F - 3/8"F (NSF)	500	8	90	10
3	1449235		3/8"F - 3/8"F (NSF)	880	8	90	10
3	1449734	520605	3/8"F - 3/8"F	1000	8	90	10
3	1449736	520606	3/8"F - 3/8"F	1500	8	90	10
3	3449300	LF3449300	1/2" Fp x CFp	1500	8	90	10
3	1449232	S0903776	3/8"F - 3/8"F (NSF)	1600	8	90	10
3	1449246	LF1449246	3/8"F - 3/8"F (ACS)	1600	8	90	10

MACHINES A CAFE CONSOMMABLES

Photo	Code LF	Code GEV	Raccords	Longueur (mm)	ø interne (mm)	Température max. (°C)	Pression max (bar)
3	1449737	520607	3/8"F - 3/8"F	2000	8	90	10
3	5500682	LF5500682	3/8"F - 3/8"F	2200	8	90	10
4	1449702	520634	3/8"M - 3/8"M	500	8	90	10
5	1449258	LF1449258	3/8"M - 3/8"F (NSF)	350	8	90	10
5	7102087	LF7102087	3/8"M - 3/8"F	380	8	90	10
5	1449259	LF1449259	3/8"M - 3/8"F (NSF)	1200	8	90	10
6	1449247	LF1449247	3/8"F - 3/8"F (ACS)	250	8	90	10
6	1449248	LF1449248	3/8"F - 3/8"F (ACS)	480	8	90	10



Code LF: 3186308

KIT JAUNE JOINT OR 404 Pcs METRIQUES NBR

assortiment de 30 dimensions
dimensions boîte 240x175x45 mm



Code LF: 3186501

MALETTE DE JOINTS TORIQUE 425 Pcs

mallette en plastique
rectifiés pour étanchéité jusqu'à 120°C
total 425 pièces des modèles les plus courants
dimensions mallette 170x105x30 mm



Code LF: 3050752

GAINE ISOLATION SILICON ø 6 mm - 10 m

ø int. 6 mm
température -60°+280°C
par rouleau de 100 m voir 3050152



Code LF: 3180107

RUBAN PTFE 12 m

épaisseur 0,10 mm - largeur 12 mm
température d'utilisation -60°+260°C
conforme aux normes UNI EN 751/3



Code LF: 3247003

BORNIER 2 POLES EN CERAMIQUE

pour câble max. 4 mm²
température d'utilisation 300°C
tension nominale 450V
dimensions 21x18x16 mm



Code LF: 3051021

COSSE FEMELLE 6,3 mm

en métal nickelé
cosse plate avec dent 6,3 mm
pour section câble ø 1 à 2,5 mm
température max. +300°C



Code LF: 7121405

COSSE A OEILLET M6 SACHET DE 10 Pcs

en cuivre nickelé
oeillet trou 6 mm
pour section câble ø 2,6 à 6,6 mm
température max. +650°C



Code LF: 3051116

CONNECTEUR DE TETE ROUGE ø 1,7 100 Pcs

section fil ø 0,5 à 1,5 mm



Code LF: 3180065

RUBAN ISOLANT NOIR EN PVC 10 m

excellente résistance à la corrosion
température d'utilisation 0 à 80°C
agrément EDF
épaisseur 0,15 mm - largeur 15 mm

MACHINES A CAFE CONSOMMABLES

VIS A TETE FRAISEE PLATE



UNI 7688
DIN 965



UNI 6109
DIN 963

Code LF	Code GEV	Dimensions (mm)	Empreinte de tête	Matière	UNI	DIN
1528116	LF1528116	M3 x 6	cruciforme	acier inox	7688	965
1528092	560322	M3 x 10	cruciforme	acier inox	7688	965
1528623	LF1528623	M4 x 6	cruciforme	acier inox	7688	965
3528291	698481	M4 x 8	cruciforme	acier inox	7688	965
1528001	LF1528001	M4 x 10	cruciforme	acier inox	7688	965
3528121	560076	M4 x 10	à fente	acier inox	6109	963
5021381	560425	M4 x 12	cruciforme	acier inox	7688	965
1528061		M4 x 14	à fente	acier inox	6109	963
3528030	LF3528030	M4 x 16	cruciforme	acier inox	7688	965
5022870		M4 x 20	cruciforme	acier inox	7688	965
3528122	S0033918	M4 x 30	à fente	acier inox	6109	963
5013493		M5 x 10	cruciforme	acier inox	7688	965
1528031	560375	M5 x 12	à fente	acier inox	6109	963
3528050		M5 x 14	cruciforme	acier inox	7688	965
1528023	560370	M5 x 16	cruciforme	acier inox	7688	965
1528011	560375	M5 x 20	cruciforme	acier inox	7688	965
5039329	560267	M5 x 25	cruciforme	acier inox	7688	965
5026833	560299	M5 x 75	cruciforme	acier inox	7689	966
9528034		M6 x 12	à fente	acier inox	6109	963
1528016	LF1528016	M6 x 16	à fente	acier inox	6109	963
5046995		M6 x 25	cruciforme	acier inox	7688	965
3528079		M6 x 35	cruciforme	acier inox	7688	965
3528087		M6 x 50	cruciforme	acier inox	7688	965
3528123		M8 x 20	à fente	acier inox	6109	963

VIS FENDUE UNI 6109 EN 22009



Code LF	Dimensions
1528031	M5x12 mm
1528137	M5x20 mm
1528016	M6x16 mm

MACHINES A CAFE OUTILS



LF Code: 1384002

BROSSE DE NETTOYAGE POUR DOUCHETTES



LF Code: 1384001

BROSSE NETTOYAGE DOUCHETTES

100% made in Italy



LF Code: 1384701

GOUPILLON 300 mm ø 3,5 mm



LF Code: 3508003

KIT 12 CLES COMBINES

dimensions 6 à 22
acier chrome vanadium DIN 3113



LF Code: 3506037

KIT 9 CLES HEXAGONALES TORX PERCEES

dimensions TX10 à TX50
acier chrome vanadium



LF Code: 3394392

MIROIR D'INSPECTION AVEC LAMPE LED

3 led avec poussoir ON/OFF - poignée
telescopique jusqu'à 53 cm avec embout
magnétique - miroir détachable (ø 3,81 cm)



LF Code: 3508004

PINCE UNIVERSELLE VDE 180 mm

DIN ISO 5746
conforme IEC/EN 60900 - VDE 0682
couleurs jaune - rouge selon les normes



LF Code: 3509003

TENAILLE "TOP CUT" 224 mm



LF Code: 3505058

PINCE COUPANTE DIAGONALE 130 mm

pour fil en acier (dureté d'environ 62 HRC)



LF Code: 5113624

PIED A COULISSE ACIER INOX AFFICHAGE NUMERIQUE

gamme de mesure 0-150 mm
tolérance 0,02 mm



LF Code: 3505076

TOURNEVIS CRUCIFORME 4 mm

longueur partie en acier 75 mm
pour tournevis de précisions



LF Code: 3505271

BOITE A OUTILS 495x390x260 mm

VOIR LA LISTE COMPLETE
SUR NOTRE SITE INTERNET
WWW.EPGC.COM

MACHINES A CAFE

OUTILS



LF Code: 3394512

MULTIMETRE DIGITAL CEM DT-922 BLEU

alimentation par pile et arrêt automatique
Vca échelles: 400mV-4V-40V-400V-600V
Vcc: échelles 400mV-4V-40V-400V-600V
Ica: échelles 400µA-4000µA-40mA-400mA-
10A
Icc: échelles 400µA-4000µA-40mA-400mA-
10A
Res.: 400ohm-4Kohm-40Kohm-400Kohm-
4000Mohm-40Mohm
Capacité: 4nF-40nF-400nF-4µF-40µF-
200µF
Freq:10Hz-100Hz-1000Hz-10kHz-100kHz-
1000kHz-10MHz
fonction HOLD pour données
résolution 1°C/1°F
température d'utilisation 0+50°C
pointes et sonde à fil type K fournis
complet avec étui
dimensions 150x70x48 mm



LF Code: 5500399

POINCEAU POUR EXTRACTION JOINT

petit poinçon adapté à l'extraction de
joints et particulièrement des joints
de groupe à café
manche en bois
longueur totale 83 mm



LF Code: 3394204

THERMOMETRE DIGITAL -50+300°C / -58+572°F

alimentation par pile et arrêt automatique
unité de mesure à sélectionner en degrés
°C/°F
précision ±1°C - résolution 0,1°C
bouton ON/OFF
fonction mémoire pour récupérer et visualiser
la dernière mesure détectée
avec sonde à piquer ø 3,5x119 mm
avec étui
outil approprié pour aliments



LF Code: 1505002

LEVIER EXTRACTEUR FILTRE INOX AVEC TROU



LF Code: 1394001

PINCE UNIVERSELLE

pour tuyaux vapeur et groupes café
extracteurs de filtre et joints de porte-filtres
clé 8/11/12/13 mm
ouvre-bouteille



LF Code: 3394551

KIT TEST ANALYSE DURETE TOTALE



LF Code: 1017004

BALANCE DIGITALE 600 g

dimensions 116x78x20 mm - piles incluses
unité de mesure: g - oz - dwt - gn
précision: 0,1g
fonction OFF automatique
fonction TARE
couleur: NOIRE



LF Code: 3092293

CHIFFON MICROFIBRE "ETERNO" - 1 PC

antibactérien testé
dimensions 400x400 mm
nettoie et désinfecte toutes les surfaces
sans détergents



LF Code: 1165500

PORTE-FILTRE AVEC THERMO-MANOMETRE

mesure la température de l'eau et la pression de sortie du groupe distribution
échelle de température 0-120°C / 0-240°F
échelle de pression 0-16 bar / 0-200 psi
avec valve à boisseau sphérique de vidange ailettes 7,2 mm



LF Code: 1080200

VERRE DOSEUR SERIGRAPHIE 15/60 ml

sérigraphie 15/60 ml - 0,5/2 oz
base ø 42,5 mm - bord ø 59,5 mm
hauteur 70 mm



LF Code: 1224902

POT A LAIT 0,60 L

en acier inox Aisi 202



LF Code: 1385066

TASSEUR ESSENTIAL BOIS BASE ø 58 mm

100% Made in Italy, la qualité et la longévité la poignée en bois a été étudiée pour garantir le rendement maximal la forme ergonomique assure une prise confortable et sûr, facile à utiliser la ligne essential est conçue avec une base fine mais sans renoncer à la haute qualité poignée en bois, base en acier inox zone de pression plate



LF Code: 1385779

TAPIS DE TASSAGE

dimensions 170x140x37 mm
avec trou support thermomètre produits laitiers
lavable au lave-vaisselle

DISTRIBUTEURS AUTOMATIQUES

KITS DE MAINTENANCE

CONSOMMABLES

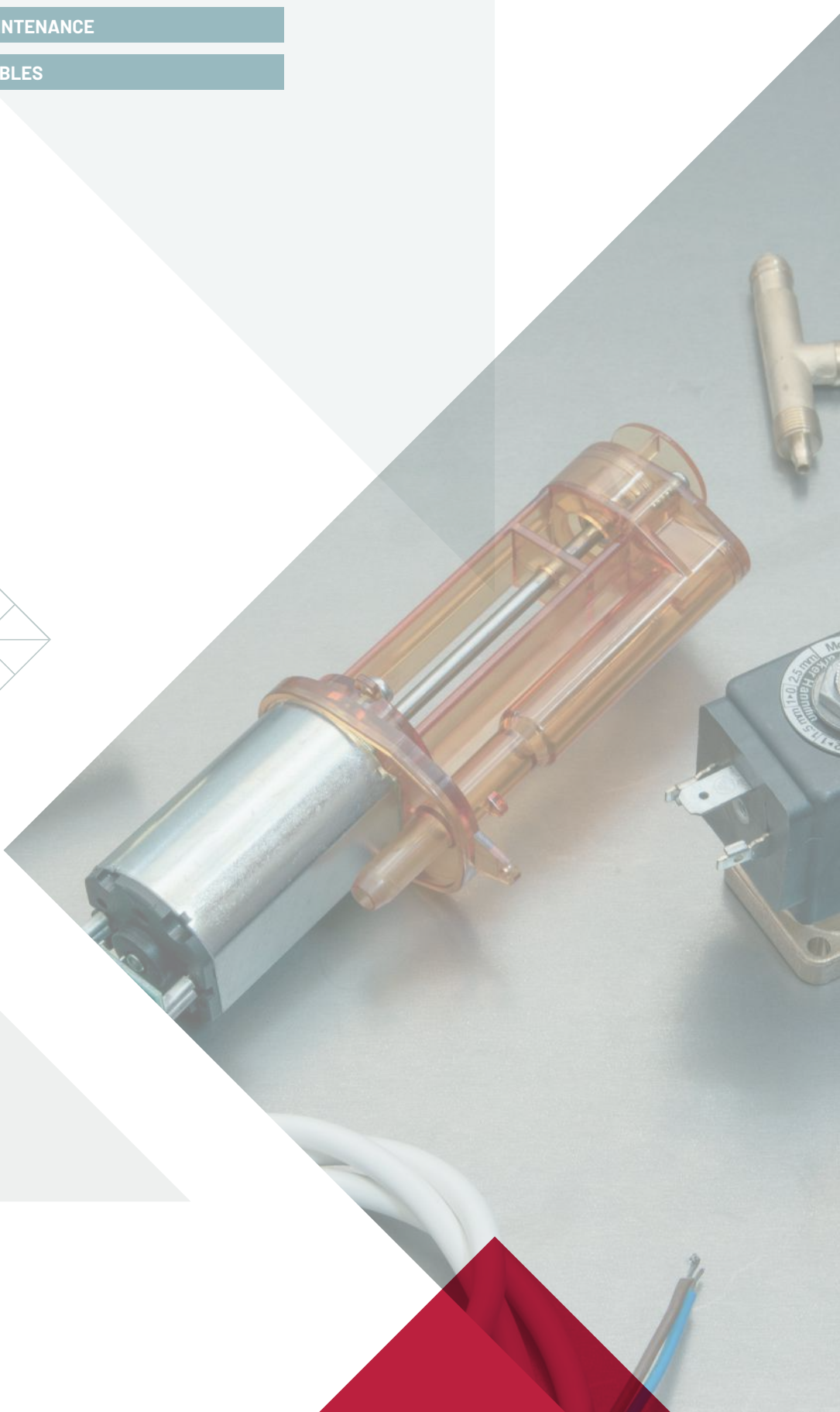
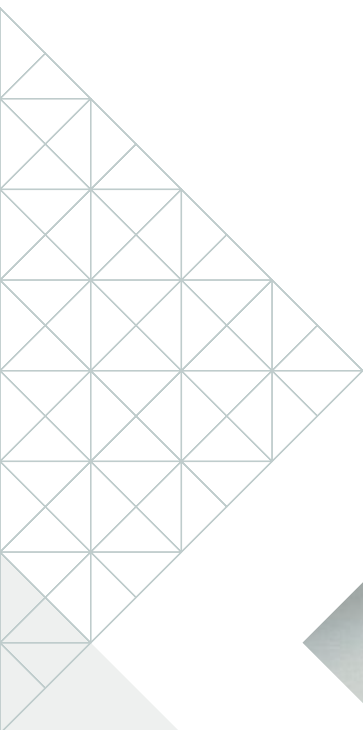

DISTRIBUTEURS AUTOMATIQUES KITS DE MAINTENANCE

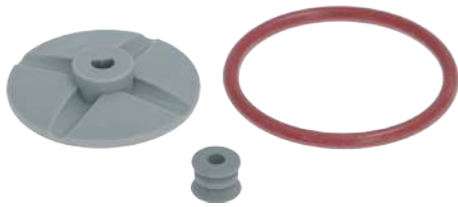

LF Code: 1095191

KIT ENTRETIEN MIXEUR RHEA VENDORS



LF Code: 1251227

KIT ENTRETIEN MEULES RHEA VENDORS

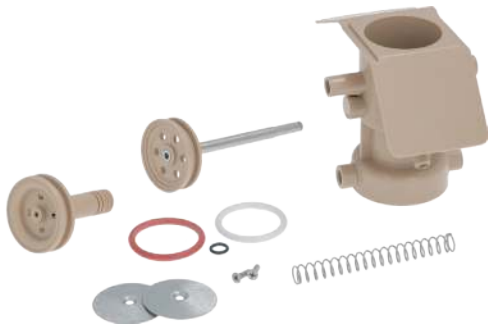

LF Code: 1900009

KIT ENTRETIEN POUR GROUPE CAFE Z3000

vendu en sachet
pour NECTA ASTRO - ASTRO DOPPIO ESPRESSO
ASTRO ESPRESSO INSTANT - BRIO - BRIO 250
BRIO 3 - BRIO C-I RISCALDATORE
per WITTENBORG 7600



LF Code: 1900017

KIT ENTRETIEN GROUPE CAFE 9 g



LF Code: 1900015

KIT ENTRETIEN GROUPE CAFE BIANCHI

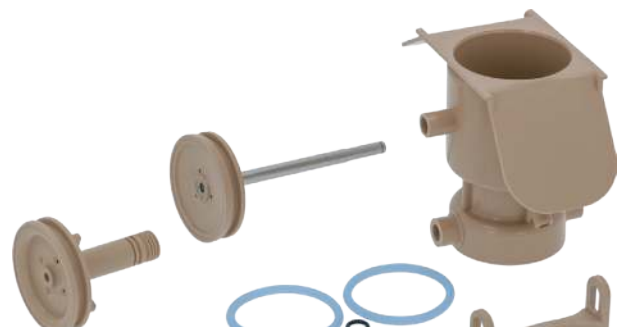

LF Code: 1900013

KIT ENTRETIEN GROUPE CAFE Z3000

version améliorée

DISPONIBLE A PARTIR DU 15 MAI 2020,
ENVOYEZ VOTRE PRE-COMMANDE SANS ATTENDRE

VOIR LA LISTE COMPLETE
SUR NOTRE SITE INTERNET
WWW.EPGC.COM

DISTRIBUTEURS AUTOMATIQUES KITS DE MAINTENANCE



LF Code: 1900008

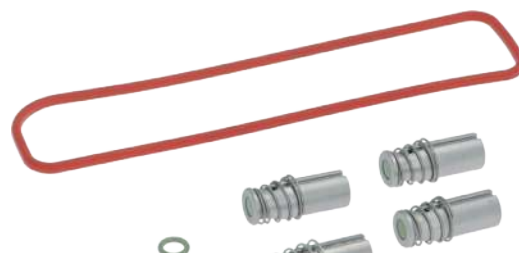

LF Code: 1900014

KIT ENTRETIEN POUR GROUPE CAFE Z4000

vendu en sachet
pour NECTA CANTO - CANTO CLASSICO ESPRESSO -
CANTO DUAL CUP - CANTO ESPRESSO INSTANT - CANTO P -
CANTO TOUCH DUAL CUP

KIT ENTRETIEN CHAUDIERE BIANCHI



LF Code: 1900012



LF Code: 1900011

KIT ENTRETIEN CHAUDIERE 300CC

vendu en sachet
pour NECTA BRIO - BRIO 250 - BRIO 3 - BRIO UP - CANTO -
CANTO DUAL CUP - CANTO TOUCH - COLIBRI' - COLIBRI' TOP -
CONCERT

KIT ENTRETIEN CHAUDIERE 600CC

vendu en sachet
pour NECTA ASTRO - ASTRO P - BRIO - BRIO 250 - BRIO 3 - BRIO UP -
CANTO - CANTO DUAL CUP - CANTO TOUCH - COLIBRI' - GRAN
pour WITTENBORG 7100 - 7100 PLUS - 7600 - ES 7100 MAXI

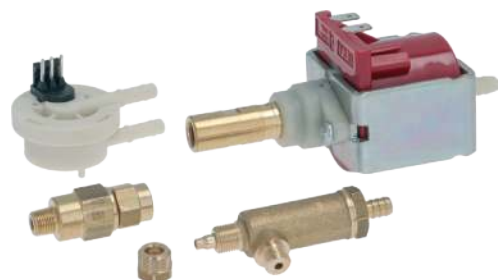

LF Code: 1900016



LF Code: 1755187

KIT POMPE BIANCHI

RESISTANCE 1500W 230V

dimensions bride 180x60 mm

**DISPONIBLE A PARTIR DU 15 MAI 2020,
ENVOYEZ VOTRE PRE-COMMANDE SANS ATTENDRE**



LF Code: 3010072

**ROBINET A BILLE
JG PPM5V040808W**

tube ø 8 mm



LF Code: 3010207

**RACCORD COUDE
JG PM0306E**

tube ø 6 mm



LF Code: 3349208

**RACCORD COUDE AVEC EMBOUT
JG PM220606E**

embout lisse ø 6 mm - pour tube ø 6 mm



LF Code: 3349196

**REDUCTEUR AVEC EMBOUT
JG PM060806E**

embout lisse 8 mm - pour tube ø 6 mm



LF Code: 7106717

**REDUCTION JG
ø 3/4\"/>**



LF Code: 3010194

**REDUCTEUR DROIT
JG PM201008E**

tube ø 10-8 mm



LF Code: 3010208

**RACCORD COUDE
JG PM0308E**

tube ø 8 mm



LF Code: 3349565

**RACCORD COUDE AVEC EMBOUT
JG PM220808E**

embout lisse ø 8 mm - pour tube ø 8 mm



LF Code: 5073187

**CLIPS DE BLOCAGE
5/16\"/>**



LF Code: 3010203

**RACCORD \"T\"
JG PM0208E**

tube ø 8 mm



LF Code: 3349120

**REDUCTEUR DROIT
JG PM200806E**

tube ø 8-6 mm



LF Code: 3349566

**RACCORD DROIT
JG CM320816FE**

F3/4\"/>



LF Code: 3010143

**RACCORD DROIT
JG PM010812E**

M1/4\"/>



LF Code: 3010183

**RACCORD DROIT
JG PM010813E**

M3/8\"/>



LF Code: 3010175

**RACCORD DROIT
JG PM0408E**

tube ø 8 mm



LF Code: 5046104

**TUBE POLYETHYLENE NOIR
LLDPE JG**

ø 8x6 mm - alimentaire - VENDU AU METRE



EPGC S.a.s.
13 Rue des Forts
59960 Neuville en Ferrain - France
Tel.: +33 3 20250621
epgc@epgc.com
www.epgc.com

